

2nd WPGD series

This LED barn light is a reliable and cost-effective light fixture that includes integrated LEDs, so no bulbs are required. It consumes 30 watts or 50 watts and produces 120LPW light efficiency to replace 100 watt metal halide fixtures. The LED barn light is easy to mount and comes fully gasketed for outdoor installation, which can be mounted on the wall with a wall bracket or to a pole with an arm mount. Also, a photocell sensor is included for dusk to dawn operations and it is effective for security and perimeter lighting. LED barn lights and LED yard lights provide energy efficient security and area lighting for rural and residential areas, such as barn lights, storage yards, parking lots, service roads and building perimeters.



FEATURES

- ETL/cETL listed for wet and outdoor locations
- 120 lumens per watt
- 100-277VAC input voltage
- IP65 rated suitable
- Photocontrol available
- 5 years warranty

2nd WPGD series

APPLICATIONS

- Wet areas
- Outside walkways
- Farm buildings (Non-corrosive atmosphere)
- Storage yards
- Building lighting
- Car parks
- Entryway
- Security lighting

CONSTRUCTION

- Heavy duty die-cast aluminum housing, fully sealed to be dirt and bug proof
- All-polycarbonate construction.
- Built-in photocell sensor
- Integral secondary heat sink to optimize thermal transfer and maximize performance and life of LED
- Driver is mounted in direct contact with the casting for a low operating temperature and long life
- Polyester powder-coated finish, rust and corrosion proof
- Stabilized to extreme climate changes without cracking or peeling
- Dark bronze, black and white finish available

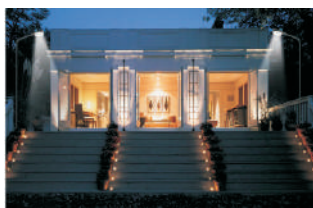

Building lighting



Parking lot lighting



Doorways lighting



Storage yards

DIMENSION:(mm/in)

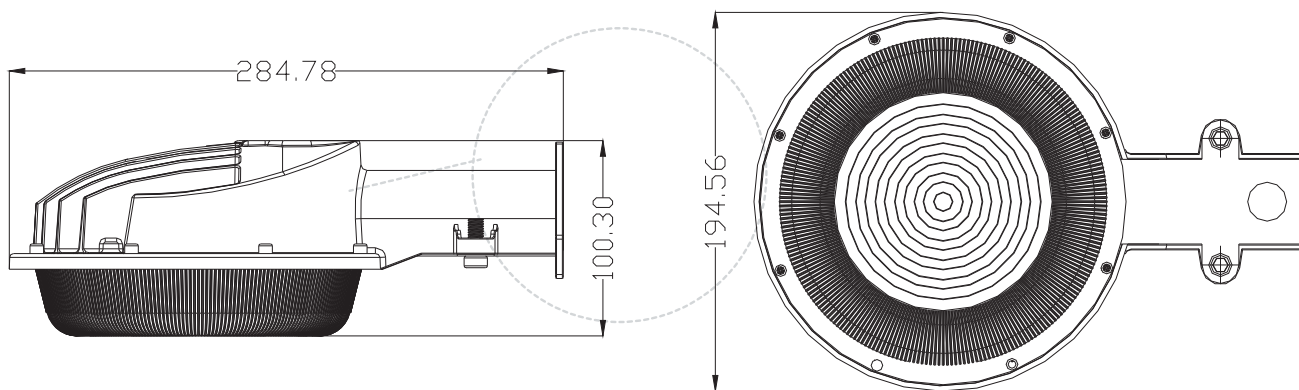

PRODUCT DETAILS



2nd WPGD series

TECHNICAL SPECIFICATION

- Input Voltage : 100-277VAC
- Driver Type : UL High performance LED drive.
- Power factor : >99%, THD <15 %
- Luminous Efficacy : up to 120lm/w
- Colour Rendering Index : > 70Ra
- LED Type : High performance LM80 SMD2835 LED
- Operating Temperature : -30°C up to 50°C
(-22°F up to 122°F)
- Color Temperature : 3000K/4000K/5000K/5700K
- Material : Aluminum Housing & durable frosted polycarbonate lens
- Ingress Protection : IP65
- Impact Rating : IK08
- Rated Life : 50,000 hours
- Warranty : 5 years

Produce Code	KLWPGD030-XXKPLL-TA-1AA	KLWPGD050-XXKPLL-TA-1AA
Power Consumption(W)	30W	50W
Lumens Delivered (lm)	3600lm	6000lm
Efficacy (lm/W)	120lm/w	120lm/w
Beam Angle	120°	120°
CRI	>70	>70
Color Temperature	3000K/4000K/5000K/5700K	3000K/4000K/5000K/5700K
Input Voltage	100-277VAC	100-277VAC
Power Factor	0.98at 100VAC 0.90at 277VAC	0.98at 100VAC 0.90at 277VAC
Housing	Die-cast aluminum body(Bronze/Black). PC diffuse	Die-cast aluminum body(Bronze/Black). PC diffuse
Installation	Direct mounting & Arm mounting	Direct mounting & Arm mounting
Operating Temperature	-30°C up to 50°C (-22°F up to 122°F)	-30°C up to 50°C (-22°F up to 122°F)
Certification	ETL/cETL	ETL/cETL
Warranty	5 years	5 years

LUMINAIRE PHOTOMETRIC

Luminous Intensity Distribution Diagram:

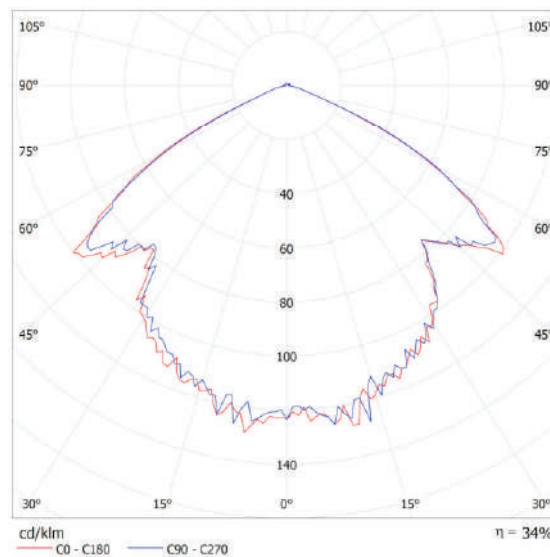
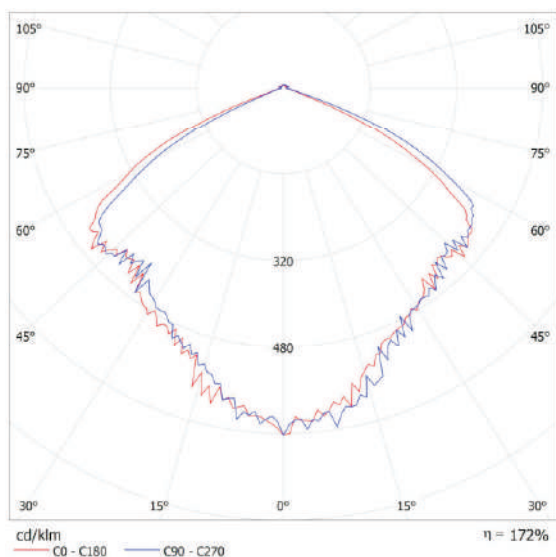

2nd WPGD series

INSTALLATION:

● Direct Mounting Instructions

1. Inspect components to ensure that male and female port threads and sealing surfaces are free of burrs, nicks and scratches or any foreign material.
2. Drill mounting holes for fixture as shown in Fig. 1.

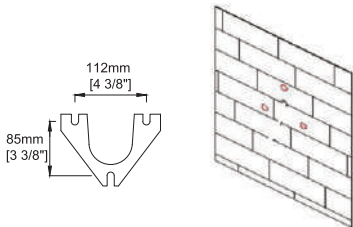

Fig. 1

3. Insert two screws (provided) into the two lower-most mounting hole locations, as shown in Fig.2. Do not tighten the screws fully.

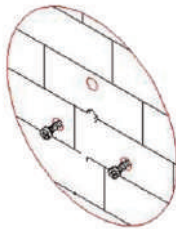

Fig. 2

● Arm Mounting Instructions

1. Inspect components to ensure that male and female port threads and sealing surfaces are free of burrs, nicks and scratches or any foreign material.
2. Inspect mounting arm; if split-arm is provided, use supplied nut and bolt to assemble arm as shown in Fig. 5.

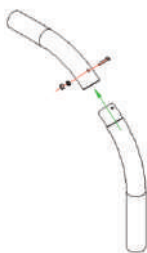

Fig. 5

3. Run extension wiring (by others) through the arm.
4. Follow General Wiring Diagram (Fig. 4) above for connecting extension wiring to luminaire. Make sure the power supply is disconnected before installing and be sure to secure any loose wiring connections safely inside wiring compartment.
5. Insert arm into the U-slot on luminaire. Use the two provided hex screws to secure arm, as shown in Fig. 6.

4. Hook the fixture onto the two inserted screws, then insert and tighten the top screw, as shown in Fig. 3. Finally, tighten the two lower-most screws.

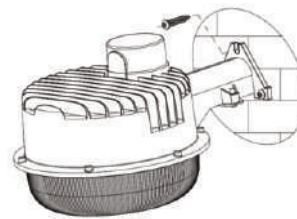

Fig. 3

5. Remove wiring compartment cover to access knockout plug. Follow General Wiring Diagram (Fig. 4) above for reference. Make sure the power supply is disconnected before installing and be sure to secure any loose wiring connections safely inside wiring compartment.
6. Secure power supply inside wiring compartment using 1/2" connector (by others).
7. Secure wiring compartment cover to fixture.

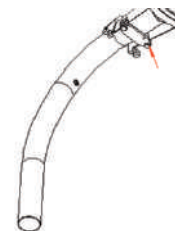

Fig. 6

6. Secure clamp onto the base of the arm, as shown in Fig. 7. Ensure that the arm does not rotate.

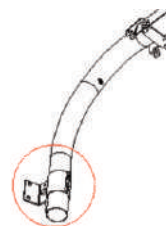

Fig. 7

7. Secure luminaire and arm to surface using four provided mounting screws, as shown in Fig. 8.

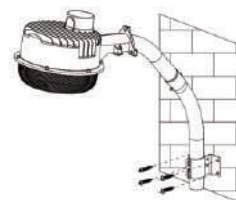

Fig. 8

8. Using conduit connector (by others) and connection plug (by others), connect extension wiring to power supply.

2nd WPGD series

Wall pack LED Barn light sales champion, quality is better than peers.



HIGH QUALITY & BETTER DESIGN
Constructed from die-cast aluminum,
Excellent heat dissipation & erosion
resistance



REMOVABLE PHOTOCELL SENSOR.
10kv surge protection. Dusk to dawn
photo cell garage.



ENERGY EFFICIENT & LONG LASTING
120lm/W for fixture, with a PC lens cover.
Waterproof rated at IP65. Eco-friendly LED
lights and dusk to dawn

EASY INSTALLATION & UPGRADE
yard light mounting arm, which
makes for an easy upgrade.



Fixtures and electrical components are UL certified to USA and Canada standards

- IP65 rated and suitable for wet locations
- 5 years warranty

2nd WPGD series

PACKAGING

Model No.	Qty (pcs)	L*W*H (CM)	NW. (kgs)	G.W. (kgs)	Meas. (CBM)
			Per CTN	Per CTN	Per CTN
KLWPGD030	4				
KLWPGD050	2				